



RB 105 Steel Bollards on Natural and Buff Perfecta Paving, Galleons Reach, Becton

Static Bollards

Steel



RB 111 Steel Bollards with yellow banding on Tegula block paving in Traditional and Pennant Grey, Harrop Fold High School, Salford

Rhino static steel bollards provide security to any landscape. The exceptional strength of steel makes it ideal for ram-raid deterrence, protected parking and the demarcation of pedestrian walkways.

Manufactured to the highest standard, Rhino steel bollards are hot dip galvanised to BS EN ISO 1461 (1999). Bollards are polyester powder coated in RAL black 9005 as standard, and can be specified to match almost any British Standard or RAL colour if required.

Specification options

Dependent on the level of protection required, a number of specification options are available:

Standard: Standard steel bollards are exceptionally strong and will not fracture on impact.

Anti Ram: For increased internal strength, a steel joist can be added. This makes the bollards ideal for ram raid deterrence and preventing any vehicles from penetrating beyond the bollard.

Fixing Options

Root Fixing: Rhino 1000mm bollards are supplied with a 500mm root depth as standard, which is to be placed underground and secured using concrete. A cross bar keys into the concrete for added strength, ensuring that the bollard cannot be moved or twisted. A variety of heights are available, however the required root depths will differ based on the option selected. Specific lengths are also available on request.

Base Plate: Bollards can be supplied complete with an integral base fixing plate which is attached to the ground using bolts. This option is ideal for applications where ground excavation is not an option.

Lift out and Lockable: Removable bollards allow temporary vehicle access and can be replaced when works are complete.

Customisation Options

Hazard Banding

- Rhino Bollards are available with an option of Class 2 reflective banding for increased visibility and safety.
- Banding is available in a choice of three standard colour options; Amber, red and white. Additional colours are available on request.

Chain Connectors: Allows a chain to be fixed to the bollards to form sections that cannot be opened.

Static Bollards

Steel



RB 101

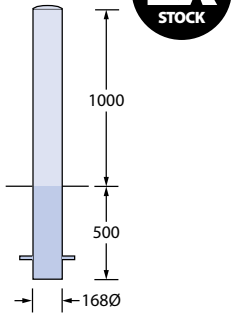

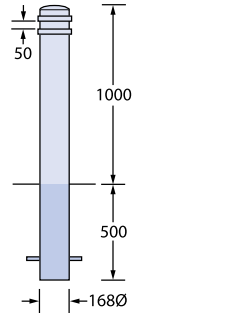

Also available ex-stock 114 x 1500

RB 105

RB 109

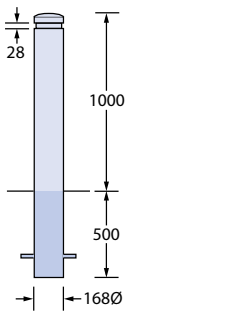
RB 111

RB 119

RB 123

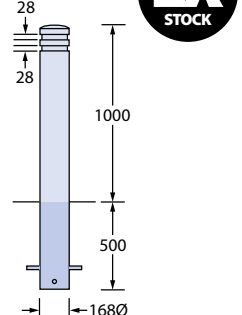
RB 150

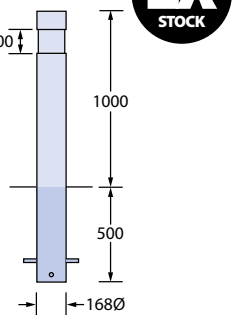
LEEDS BOLLARD

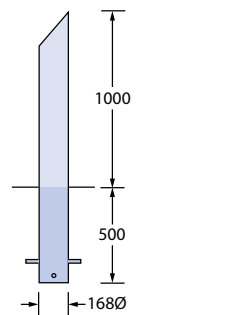
Static Bollards

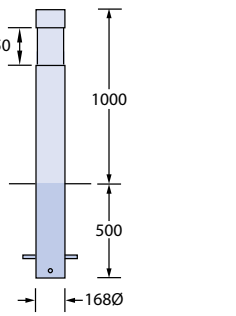
Steel

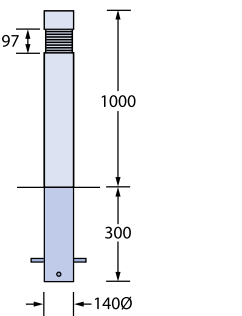

RB 119 bollards, City of Manchester Stadium

Product Description	Product Reference	Diameter (mm)	Height			Weight (kg)	Standard Finish	Optional Heights		Cap		Fixing Method		Spec Anti Ram	Finish Galv. Only	Add Ons	
			Overall Height (mm)	HAG (mm)	Weight (kg)			Length 1250 / HAG 900 (mm)	Length 1800 / HAG 1200 (mm)	Flat Cap	Separate Cap	Base Plate	Lift Out & Lockable**			Hazard Banding	Chain Connectors
Semi dome top plain bollard	RB 101	114	1500	1000	20	PC Black 9005	■	■	■	■	■	■	■	■	■	■	■
	RB 101	139	1500	1000	25	PC Black 9005	■	■	■	■	■	■	■	■	■	■	■
	RB 101	168	1500	1000	30	PC Black 9005	■	■	■	■	■	■	■	■	■	■	■
	RB 101	194	1500	1000	40	PC Black 9005	■	■	■	■	■	■	■	■	■	■	■
Semi dome top double ring bollard	RB 105	114	1500	1000	20	PC Black 9005	■	■	■	■	■	■	■	■	■	■	■
	RB 105	139	1500	1000	25	PC Black 9005	■	■	■	■	■	■	■	■	■	■	■
	RB 105	168	1500	1000	30	PC Black 9005	■	■	■	■	■	■	■	■	■	■	■
	RB 105	194	1500	1000	40	PC Black 9005	■	■	■	■	■	■	■	■	■	■	■
Semi dome single indent bollard	RB 109	114	1500	1000	20	PC Black 9005	■	■	■	■	■	■	■	■	■	■	■
	RB 109	139	1500	1000	25	PC Black 9005	■	■	■	■	■	■	■	■	■	■	■
	RB 109	168	1500	1000	30	PC Black 9005	■	■	■	■	■	■	■	■	■	■	■
	RB 109	194	1500	1000	40	PC Black 9005	■	■	■	■	■	■	■	■	■	■	■
Semi dome double indent bollard	RB 111	114	1500	1000	20	PC Black 9005	■	■	■	■	■	■	■	■	■	■	■
	RB 111	139	1500	1000	25	PC Black 9005	■	■	■	■	■	■	■	■	■	■	■
	RB 111	168	1500	1000	30	PC Black 9005	■	■	■	■	■	■	■	■	■	■	■
	RB 111	194	1500	1000	40	PC Black 9005	■	■	■	■	■	■	■	■	■	■	■
Flat top large indent bollard	RB 119	114	1500	1000	20	PC Black 9005	■	■	■	■	■	■	■	■	■	■	■
	RB 119	139	1500	1000	25	PC Black 9005	■	■	■	■	■	■	■	■	■	■	■
	RB 119	168	1500	1000	30	PC Black 9005	■	■	■	■	■	■	■	■	■	■	■
	RB 119	194	1500	1000	40	PC Black 9005	■	■	■	■	■	■	■	■	■	■	■
Mitre top bollard	RB 123	114	1500	1000	20	PC Black 9005	■	■	■	■	■	■	■	■	■	■	■
	RB 123	139	1500	1000	25	PC Black 9005	■	■	■	■	■	■	■	■	■	■	■
	RB 123	168	1500	1000	30	PC Black 9005	■	■	■	■	■	■	■	■	■	■	■
	RB 123	194	1500	1000	40	PC Black 9005	■	■	■	■	■	■	■	■	■	■	■
Flat top bollard with single DDA band	RB 150	114	1500	1000	20	PC Black 9005	■	■	■	■	■	■	■	■	■	■	■
	RB 150	139	1500	1000	25	PC Black 9005	■	■	■	■	■	■	■	■	■	■	■
	RB 150	168	1500	1000	30	PC Black 9005	■	■	■	■	■	■	■	■	■	■	■
	RB 150	194	1500	1000	40	PC Black 9005	■	■	■	■	■	■	■	■	■	■	■
Leeds Bollard	Leeds Bollard	140	1300	1000	25	PC Grey 706								■			

*Bold text indicates standard bollard option

** Lift and Lockable option available dependant on diameter